

Drilling Sequences for TSIV SA Fixture

Taper KIT User

∅ 4.0mm Fixture (Length : 10mm)

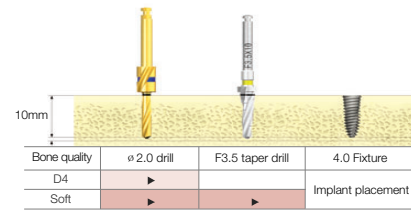

∅ 4.5mm Fixture (Length : 10mm)

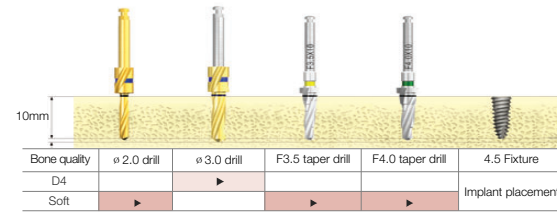

∅ 5.0mm Fixture (Length : 10mm)

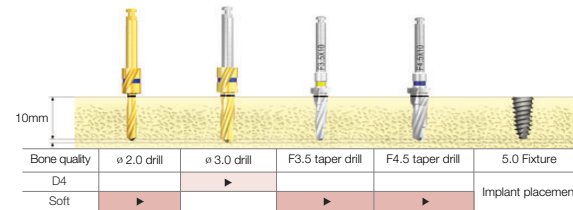

Straight Drill User

∅ 4.0mm Fixture (Length : 10mm)

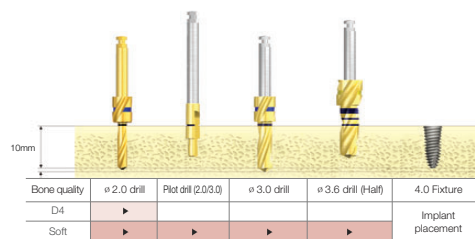

∅ 4.5mm Fixture (Length : 10mm)

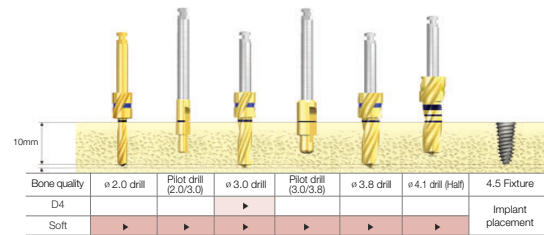

∅ 5.0mm Fixture (Length : 10mm)

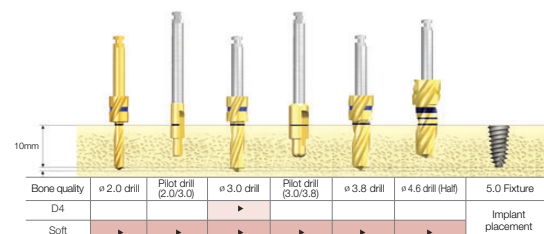

※ Because TSIV SA fixture is especially developed for maxilla and soft bones, there is no surgical sequence for normal bones.

CAS KIT User

Fixture	Bone Quality	∅ 2.0 Drill	CAS ∅ 2.8	CAS ∅ 3.1	CAS ∅ 3.3	CAS ∅ 3.6	CAS ∅ 3.8	CAS ∅ 4.1
∅ 4.0	Soft	▶	▶					
	Normal	▶		▶				
∅ 4.5	Soft	▶	▶		▶			
	Normal	▶		▶		▶		
∅ 5.0	Soft	▶	▶				▶	
	Normal	▶		▶				▶

TSIV SA Implant System Catalog & Manual

Characteristics

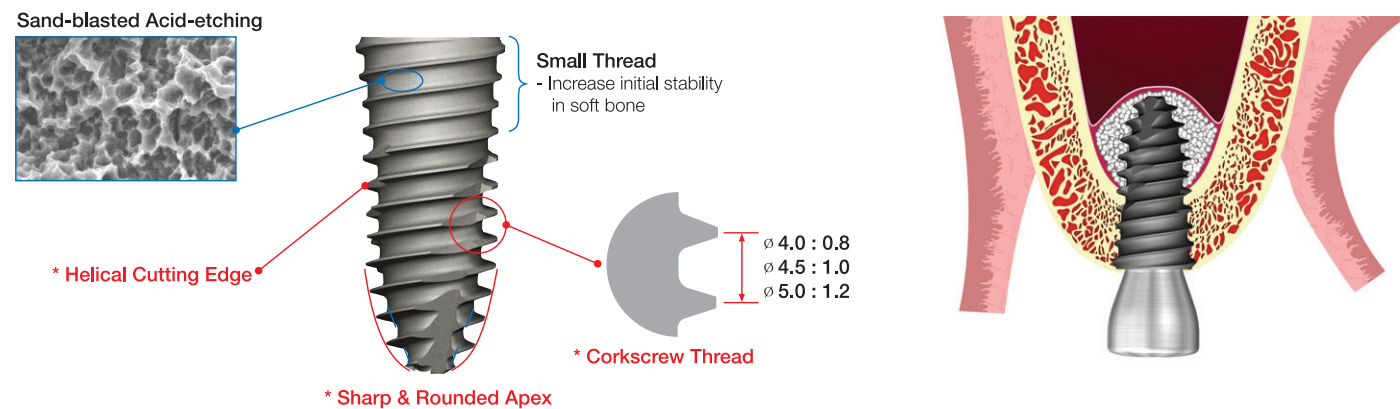

Implant that specially performs in the weaker bone

- Specially developed for maxilla and soft bones
- * High success rate even with poor bone quality.
- Improved design for initial stability and simplified surgical sequences
- * Improved the initial stability with improved application of helical cutting, corkscrew thread, and sharp and rounded apex design where implant can be placed with minimal drilling. (ϕ 2 or ϕ 3mm can be used on D4 bone)
- Recommended insertion torque : below 40Ncm
- Submerged-type implant with morse tapered internal hex connection
- Excellent self-tapping ability
- Implant that does not need osteotome

SA surface

OSSTEM's SA surface morphology and roughness increased by 45% compared to RBM treatment.

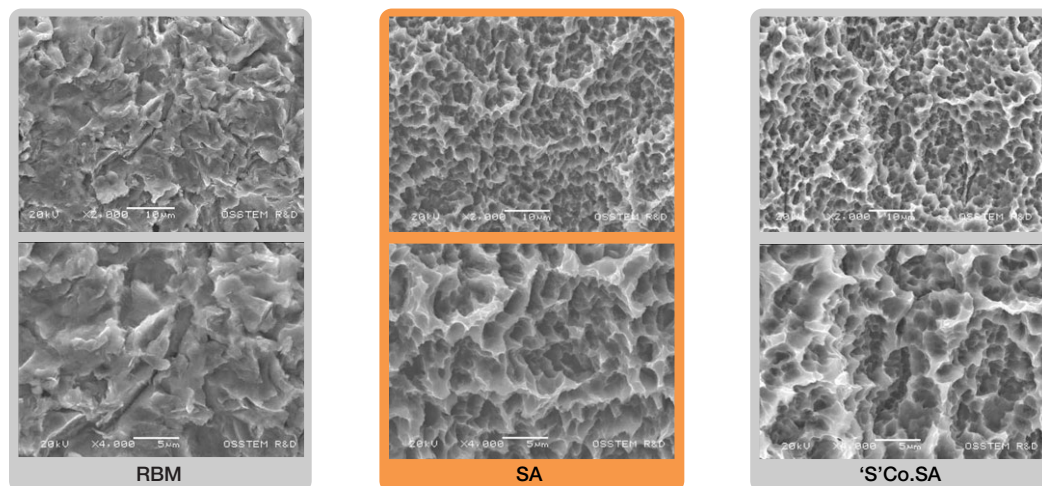

SEM (Scanning Electron Microscope) image

- SA : Sand blasted with alumina and Acid etched surface
 - Optimal morphology : combine crater and micro-pit
 - Optimal surface roughness : Ra 2.5~3.0 μ m
 - Early cell response : 20% higher than RBM
 - Early bone healing : 20% higher than RBM
 - Early loading possible after 6 weeks after implantation

Specifications

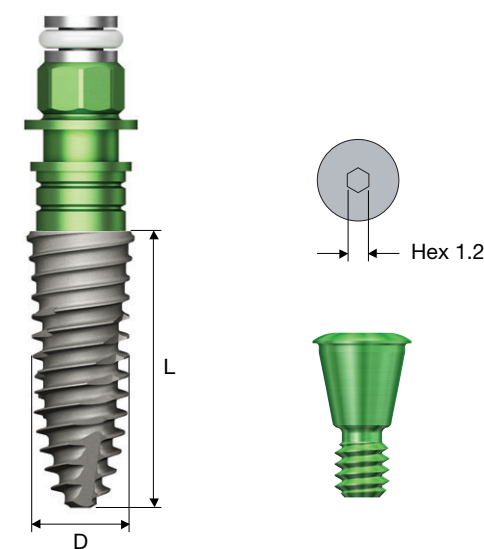

TSIV SA Fixture Order Code

Fixture Only

- Fixture : Product Code [ex : TS4S4010S]

Pre-Mounted Fixture [Simple Mount]

- Fixture + Mount + Cover Screw : B + Product Code [ex : BTS4S4010S]

Regular Diameter ϕ 4.0

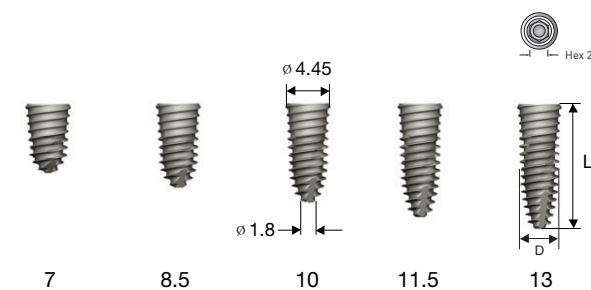

Connection		Regular
L	D	ϕ 4.0(Pitch 0.8)
7		TS4S4007S
8.5		TS4S4008S
10		TS4S4010S
11.5		TS4S4011S
13		TS4S4013S

Regular Diameter ϕ 4.5

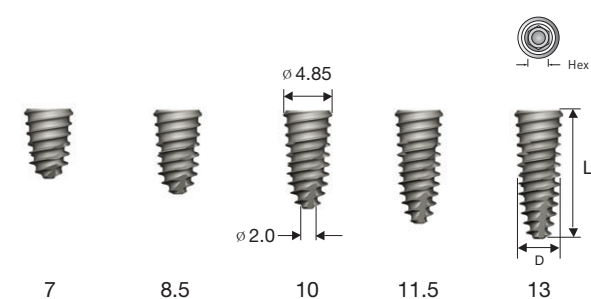

Connection		Regular
L	D	ϕ 4.5(Pitch 1.0)
7		TS4S4507S
8.5		TS4S4508S
10		TS4S4510S
11.5		TS4S4511S
13		TS4S4513S

Regular Diameter ϕ 5.0

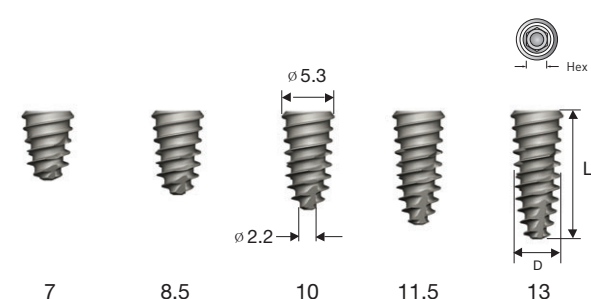

Connection		Regular
L	D	ϕ 5.0(Pitch 1.2)
7		TS4S5007S
8.5		TS4S5008S
10		TS4S5010S
11.5		TS4S5011S
13		TS4S5013S

※ For posterior single tooth case, ϕ 4.5mm or larger is recommended / ※ Actual dimensions may be different